

SPECIFICATION

STAGE V



TRACKED EXCAVATOR | 220X

Max Engine Power: 129kW | Max Operating weight: 24,743kg | Max Bucket capacity: 1.25 m²



INTRODUCING THE FIRST OF THE NEW X SERIES.

Our vision from the start was to design and engineer our most advanced 20 tonne tracked excavator. In fact, our best ever. Listening to customer demands, our engineering teams have obsessed over every minute detail of this world-class excavator. Using automotive quality materials and proven components, our design is both rugged and refined. The result is a machine to be taken seriously. A machine to be trusted.



EXTREME STRENGTH.

The 220X has undergone 4 years of development and thousands of hours of extreme testing, from climate testing (55°C to -30°C) to machine shaker rig testing.



EXCEPTIONAL COMFORT.

Our spacious JCB CommandPlus cab features the industry-leading Grammer seat, low noise levels and powerful new HVAC for optimum performance.

EXPERIENCE GREATER PERFORMANCE.

Large diameter hydraulic hoses and an innovative hydraulic regeneration system provide faster cycle times and reduced fuel consumption.



EXCELLENT CONTROL.

Proven Japanese components deliver precision and efficiency, while customisable electro-proportional controls give operators easier use of attachments.

EXTRAORDINARY ATTENTION TO DETAIL.

Building the 220X involved a huge investment in state-of-the-art facilities, with new tooling, EPD coating and robot welding.

SPECIFICATION 210X LC, 220X LC/SLC

STATIC DIMENSIONS

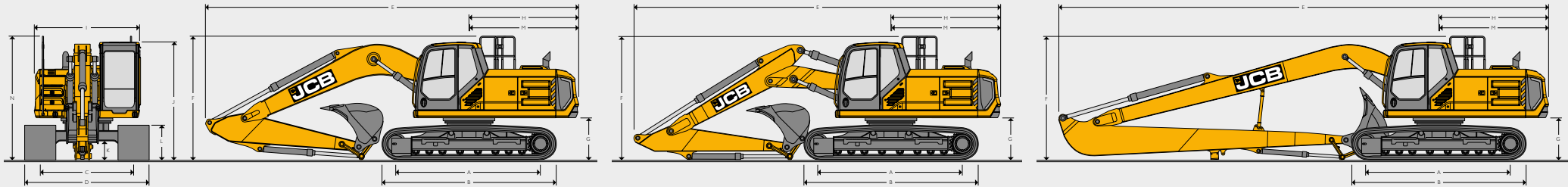

Model		210X LC, 220X LC		220X SLC			
A	Track length on ground	mm	3660		3660		
B	Undercarriage overall length	mm	4460		4460		
C	Track gauge	mm	2390		2170		
D	Width over tracks (500mm trackshoes)	mm	2890		2670		
D	Width over tracks (600mm trackshoes)	mm	2990		2770		
D	Width over tracks (700mm trackshoes)	mm	3090		2870		
D	Width over tracks (800mm trackshoes)	mm	3190		2970		
D	Width over tracks (900mm trackshoes)	mm	3290		-		
G	Counterweight clearance	mm	1077		1077		
H	Tail length	mm	2813		2813		
I	Overall width of superstructure	mm	2698		2698		
I	Overall width of superstructure (with SIPS)	mm	2828		2828		
J	Height over cab	mm	3020		3020		
J	Height over XD guard	mm	3120		3120		
J	Height over cab (vandal guard – optional)	mm	3330		3330		
K	Ground clearance	mm	485		485		
L	Track height	mm	885		885		
M	Tail swing radius	mm	2846		2846		
N	Overall height of upper structure	mm	3170		3170		
			Mono		LR		
				T.A.B			
			2.4m	3.0m	6.4m		
E	Transport length	mm	9624	9562	9622	9409	12546
F	Transport height (handrail folded – optional) *	mm	3200	3086	3266	3152	3079
	Transport height (fixed handrail – standard)	mm	3200	3170	3266	3170	3170

ENGINE

Model	JCB 448 DIESELMAX Stage V
Type	4 stroke, 4 cylinder in-line, direct injection, turbocharged diesel.
Rated power (net)	129 kW (173 hp).
Piston displacement	4.8 litres.
Air filtration	Dry element with in cab warning indicator.
Starting system	24 volt.
Batteries	2 x 12 volt.
Alternator	28 volt - 100 ampere.
Maximum torque	690 Nm @ 1500 rpm.
Bore and stroke	106 x 135 mm.

SWING SYSTEM

Swing motor	Axial piston type.
Swing brake	Hydraulic braking plus automatic spring applied disc type parking brake.
Swing torque	68.7 kNm.
Swing speed	11.0 rpm.
Swing gear	Large diameter, internally toothed fully sealed grease bath lubricated.
Swing lock	Switchable brake in cab.

*Excludes FOPS guard / XD FOPS guard.

SPECIFICATION 210X LC, 220X LC/SLC

TRACK DRIVE	
Type	Fully hydrostatic, two speed with autoshift.
Travel motors	Variable swash axial piston type, fully guarded within undercarriage frame.
Final drive	Planetary reduction, bolt-on sprockets.
Service brake	Hydraulic counter balance valve.
Park brake	Disc type, spring applied, automatic hydraulic release.
Gradeability	70% (35°) continuous.
Travel speed	High – 5.7 km/h. Low – 3.2 km/h.
Tractive effort	207.5 kN.

SERVICE CAPACITIES		
Fuel tank	Litres	387
Engine coolant	Litres	38
Engine oil	Litres	20.4
Swing reduction gear	Litres	8
Track reduction gear (each side)	Litres	3.5
Hydraulic system	Litres	250
Hydraulic tank	Litres	120
DEF fluid	Litres	47.7

UNDERCARRIAGE					
Carriage options	LC – Long Carriage, SLC – Standard Long Carriage.				
Construction	Fully welded 'X' frame type with central bellyguarding and sloping sidemembers with dirt relief holes under top rollers.				
Recovery point	Front and rear.				
Upper and lower rollers	Heat treated, sealed and lubricated.				
Track adjustment	Grease cylinder type.				
Track idler	Sealed and lubricated, with spring cushioned recoil.				
Track type	Sealed and lubricated.				
Track shoe options	500mm	600mm	700mm	800mm	900mm
	LC	LC	LC	LC	LC
	SLC	SLC	SLC	SLC	–
	LC, SLC				
No. of upper rollers (per side)	2				
No. of lower rollers (per side)	8				
No. of track guides (per side)	2				
No. of track shoes (per side)	49				

SOUND LEVEL	
Operator Sound Pressure Level – ISO 6396: 2008	67 dB LpA
Exterior Sound Pressure Level – ISO 6396: 2008 & EU Directive 2000/14/EC	102 dB LwA

HYDRAULIC SYSTEM	
Pumps	
Main pumps	2 variable displacement axial piston type.
Maximum flow	2 x 228 l/min.
Servo pump	Gear type.
Servo pump maximum flow	16 l/min.

Control valve
A combined four and five spool control valve with auxiliary service spool as standard.

Relief valve settings	
Boom/Arm/Bucket	343 bar.
With power boost	373 bar.
Swing circuit	250 bar.
Travel circuit	343 bar.
Pilot control	39 bar.

Filtration	
In tank	105 micron, suction strainer.
Main return line	10 micron, glass fibre element.
Pilot drain line	10 micron, glass fibre element.
Pilot line	10 micron, glass fibre element.
Hydraulic hammer return	10 micron, reinforced microform element.

	Quantity	Bore mm	Rod diameter mm
Boom	2	125	85
Arm	1	130	95
Bucket	1	115	85
LR Bucket	1	95	70
TAB position	1	140	95

OPTIONAL BLADE – 220X LC

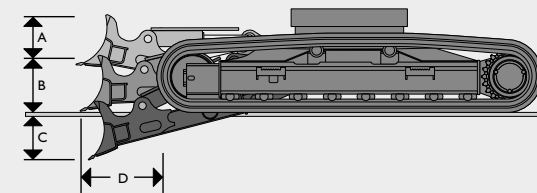

A	Blade height	mm	600
B	Blade lift above ground	mm	410
C	Blade cut below ground	mm	440
D	Blade forward of track	mm	567
	Dozer width – 600mm tracks	mm	2990
	Dozer width – 700mm tracks	mm	3110

Additional machine weight with blade		
600mm tracks	kg	1588
700mm tracks	kg	1602

SPECIFICATION 210X LC, 220X LC/SLC

BUCKET AND ARM COMBINATION - MONOBOOM

Bucket options	GP Bucket								HD Bucket							
	mm	600	700	900	1100	1200	1350	1500	600	750	900	1100	1200	1350	1500	
Bucket width	m ³	0.38	0.51	0.66	0.81	0.95	1.10	1.25	0.38	0.52	0.66	0.81	0.95	1.11	1.25	
Bucket weight	kg	506	565	637	691	763	817	889	544	610	691	752	813	894	955	
210X LC																
2.4m Quickhitch (No Quickhitch)		☐ (☐)	☐ (☐)	☐ (☐)	☐ (☐)	☐ (☐)	☐ (☐)	☐ (☐)	☐ (☐)	☐ (☐)	☐ (☐)	☐ (☐)	☐ (☐)	☐ (☐)	☐ (☐)	
3.0m Quickhitch (No Quickhitch)		☐ (☐)	☐ (☐)	☐ (☐)	☐ (☐)	☐ (☐)	☐ (☐)	■ (☐)	☐ (☐)	☐ (☐)	☐ (☐)	☐ (☐)	☐ (☐)	☐ (☐)	■ (☐)	
220X LC																
2.4m Quickhitch (No Quickhitch)		☐ (☐)	☐ (☐)	☐ (☐)	☐ (☐)	☐ (☐)	☐ (☐)	☐ (☐)	☐ (☐)	☐ (☐)	☐ (☐)	☐ (☐)	☐ (☐)	☐ (☐)	☐ (☐)	
3.0m Quickhitch (No Quickhitch)		☐ (☐)	☐ (☐)	☐ (☐)	☐ (☐)	☐ (☐)	☐ (☐)	■ (☐)	☐ (☐)	☐ (☐)	☐ (☐)	☐ (☐)	☐ (☐)	☐ (☐)	■ (☐)	
220X SLC																
2.4m Quickhitch (No Quickhitch)		☐ (☐)	☐ (☐)	☐ (☐)	☐ (☐)	☐ (☐)	☐ (☐)	☐ (☐)	☐ (☐)	☐ (☐)	☐ (☐)	☐ (☐)	☐ (☐)	☐ (☐)	☐ (☐)	
3.0m Quickhitch (No Quickhitch)		☐ (☐)	☐ (☐)	☐ (☐)	☐ (☐)	☐ (☐)	☐ (☐)	■ (☐)	☐ (☐)	☐ (☐)	☐ (☐)	☐ (☐)	☐ (☐)	☐ (☐)	■ (☐)	

☐ = Suitable for general excavating materials up to 2000kg/m³.

■ = Suitable for light excavating materials up to 1600kg/m³.

● = Suitable for grading and loading materials up to 1200kg/m³.

These recommendations are given as a guide based on typical operating conditions.

Please contact your distributor for the correct selection of buckets and attachments to suit the application.

WEIGHTS AND GROUND BEARING PRESSURES

Figures include 1.1m³. bucket 778kg, operator, full fuel tank and 2.4m dipper.

		500mm shoes	600mm shoes	700mm shoes	800mm shoes	900mm shoes
210X LC Monoboom						
Machine weight	kg	22037	22288	22561	22891	23126
Ground bearing pressure	kg/cm ²	0.53	0.44	0.39	0.34	0.31
220X SLC Monoboom						
Machine weight	kg	22730	23002	23275	23605	-
Ground bearing pressure	kg/cm ²	0.54	0.46	0.40	0.35	-

WEIGHTS AND GROUND BEARING PRESSURES

Figures include 1.1m³. bucket 778kg, operator, full fuel tank and 2.4m dipper.

		500mm shoes	600mm shoes	700mm shoes	800mm shoes	900mm shoes
220X LC Monoboom						
Machine weight	kg	22937	23188	23461	23791	24026
Ground bearing pressure	kg/cm ²	0.55	0.46	0.40	0.36	0.32
220X LC T.A.B.						
Machine weight	kg	23653	23905	24177	24508	24743
Ground bearing pressure	kg/cm ²	0.57	0.48	0.41	0.37	0.37
220X LC LR						
Machine weight	kg	23461	23712	23985	24315	24550
Ground bearing pressure	kg/cm ²	0.56	0.47	0.41	0.36	0.33

SPECIFICATION 210X LC, 220X LC/SLC

WORKING RANGE – MONOBOOM 5.7M

Dipper length:		2.4m	3.0m
A	Maximum digging reach	mm 9361	9859
B	Maximum digging reach (on ground)	mm 9171	9679
C	Maximum digging depth	mm 6096	6694
D	Maximum digging height	mm 9002	9087
E	Maximum dumping height	mm 6408	6537
F	Maximum vertical wall cut depth	mm 5368	5706
G	Minimum swing radius	mm 3331	2884
H	Minimum dumping height	mm 2906	2306
	Bucket rotation	degrees 183	183
	Maximum dipper tearout	kN 126.6	106.1
	Maximum bucket tearout	kN 150	150

WORKING RANGE – T.A.B. 5.7M

Dipper length:		2.4m	3.0m
A	Maximum digging reach	mm 9418	9955
B	Maximum digging reach (on ground)	mm 9229	9776
C	Maximum digging depth	mm 5716	6297
D	Maximum digging height	mm 10514	10890
E	Maximum dumping height	mm 7742	8120
F	Maximum vertical wall cut depth	mm 4841	5418
G	Minimum swing radius	mm 2602	2275
H	Minimum dumping height	mm 3683	3008
	Bucket rotation	degrees 183	183
	Maximum dipper tearout	kN 125	103.4
	Maximum bucket tearout	kN 148	148

WORKING RANGE – LR 8.7M

Dipper length:		6.4m
A	Maximum digging reach	mm 15628
B	Maximum digging reach (on ground)	mm 15514
C	Maximum digging depth	mm 11985
D	Maximum digging height	mm 12710
E	Maximum dumping height	mm 10451
F	Maximum vertical wall cut depth	mm 9307
G	Minimum swing radius	mm 5427
H	Minimum dumping height	mm 1730
	Bucket rotation	degrees 183
	Maximum dipper tearout	kN 68.4
	Maximum bucket tearout	kN 99.8

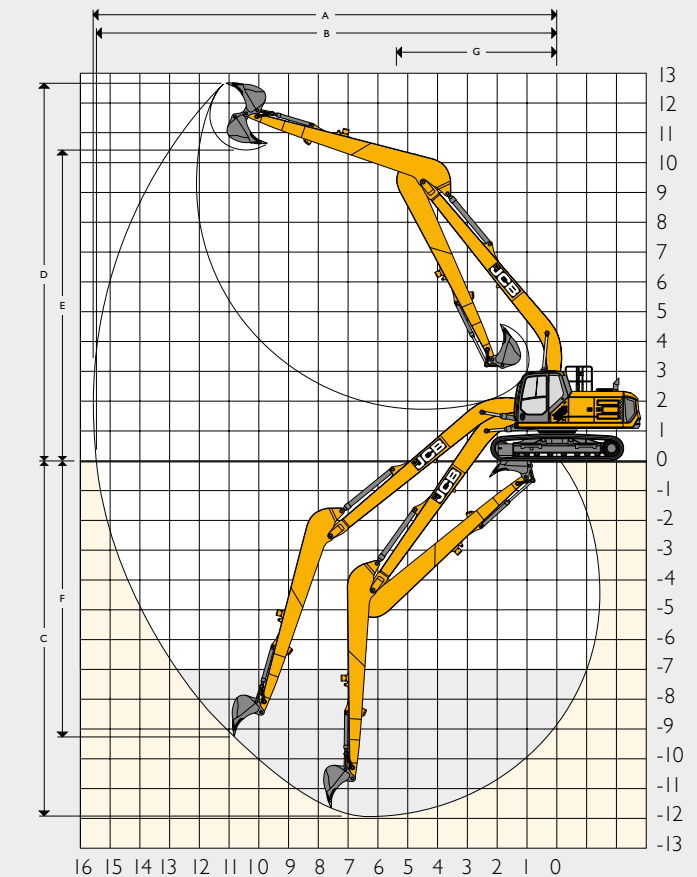
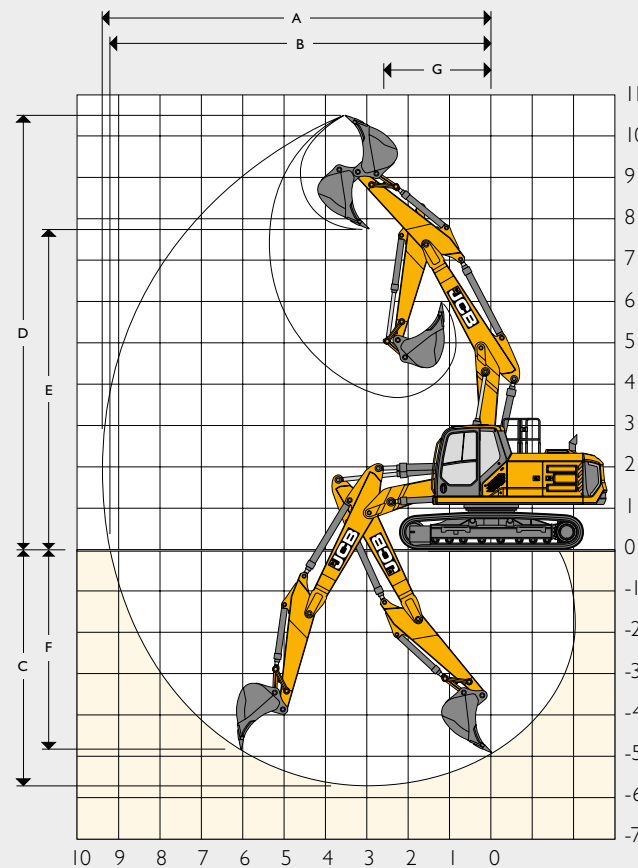
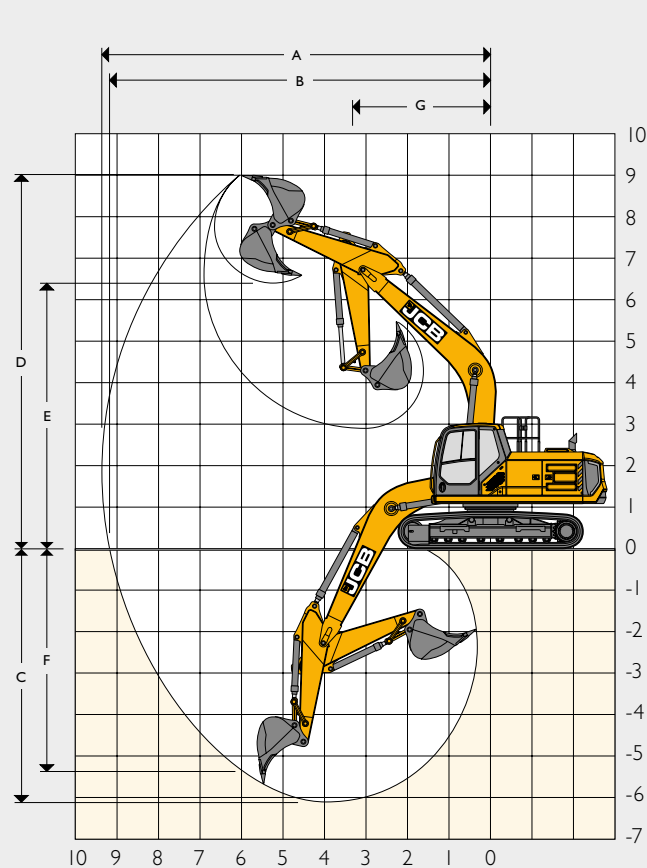

Working dimensions calculated using 980/B0092 GP bucket on Monoboom and T.A.B. and 980/A0391 GP bucket on LR.









SPECIFICATION 210X LC, 220X LC/SLC





STANDARD/OPTIONAL EQUIPMENT

ENGINE		CAB & INTERIOR		HYDRAULIC SYSTEM	
JCB 448 DIESELMAX Stage V compliant, DOC + SCRf, water cooled diesel turbocharged after cooled electronic 4 cylinder 4.8 litre engine	•	Sound-insulated and 4 dual shock mounted cab	•	Boom and arm flow regeneration	•
Start pre-heat	•	Opening front window and removable lower front window	•	One touch power boost	•
One touch idle	•	Upper door sliding glass in 2 directions	•	Boom/slew priority control	•
Auto-idle function	•	Upper door sliding glass in 2 directions	•	Cushion control	•
Automatic engine shutdown	•	Upper windscreen wiper	•	Cylinder cushioning and contamination seals	•
Fan guard	•	4 button joysticks	•	2 speed track motors	•
Heavy-duty batteries	•	Travel pedals and T handle levers	•	Oil cooler	•
Fuel filter with sedimenter	•	2 foot rests	•	I0 attachment settings through the display	•
Electronic engine control	•	Immobiliser	•	High, merged, medium and low flow options (shut off taps as standard)	+
Fuel cooler	•	Loudspeakers and connection for radio	•	Advanced tool select to control flow and pressure	+
Refuelling pump	•	Standard cab filtration	•	Proportional control joystick sliders with electronic foot pedal	+
Additional fuel filter with water separator	+	Electric dual tone horn	•	Bio oil	+
SAFETY		Interior cab light	•	Panolin oil	+
Side guard rails on upper structure and steps	•	3 x 12v sockets	•	Quickhitch pipework	+
Rear view camera	•	7" colour monitor	•	Hydraulic quickhitch	+
Battery isolator	•	Retractable 2" seat belt	•	ISO/SAE change over	+
Key	•	Fixed roof glass	•	SAE to BSP converters on high flow auxiliary pipework	+
Lockable fuel tank cap	•	Roof blind	•	Quick release couplings	+
Lockable hydraulic tank cap	•	Cool box	•	Hose burst check valves (boom, arm & bucket)	+
Work lights (2 revolving frame, 2 boom mounted)	•	Cup holder	•	Boom float	+
Roll over protective structure (ROPS)	•	Climate control	•	Auxiliary vent to tank	+
Travel alarm	•	3" seat belt	+	Attachment case drain	+
Additional light options (Levels 2 & 3 available in halogen or LED)	+	2" hi vis seat belt	+	DIG END	
White noise alarm	+	3" hi vis seat belt	+	Grouped greasing	•
Demolition cage (FOPS Level II) – XD build only	+	Front, rear and side window blind	•	Auto greasing	+
Green beacon linked to seat belt	+	Bluetooth radio (linked to pod controls and screen)	•	Dippers 2.4m, 3.0m	+
FOPS Level II guard top and front	+	Carbon air filter	+	HD dipper 2.4m, 3.0m	+
Fire extinguisher (1kg powder)	+	Deluxe seat: Heated, adjustable air suspension seat with adjustable headrest mechanical lumbar support	•	Lifting hook tipping link	+
Vandal guards	+	Super deluxe seat: Heated and air ventilation, adjustable air suspension seat with adjustable head rest and electric lumbar support	+	Lifting shackle tipping link	+
Chevron counterweight	+	Rain guard visor	+	Bucket ram guard	+
Rotating roof beacon	+	Dual front wiper	+	Triple articulated boom	+
2 x counterweight beacons	+	UNDERCARRIAGE		Guards for boom mounted lights	+
Twin camera	+	Greased and sealed track links	•	OTHER	
360 degree camera	+	Twin track guards	•	Hour meter	•
Folding handrails	+	Full length track guards	+	Toolbox and storage tray	•
Full upper surrounding handrails	+	500, 600, 700, 800, 900 mm triple grouser shoe	+	Wide core radiators	•
Arm limiter	+	Dozer for LC carriage 600mm or 700mm tracks	+	LiveLink telematics	•
				HD slew bearing seal	•
				I0mm heavy-duty plates for upper and lower structure	+
				Pleated radiator flyscreen	+
				Work light guards	+
				Service bay and access lighting	+
				GPS ready	+
				Side impact protection revolving frame	+
				Shovel storage	+
				Toolkit	•

STANDARD •
OPTIONAL +

SPECIFICATION 210X LC, 220X LC/SLC

LIFT CAPACITIES – DIPPER LENGTH: 2.4M, MONOBOOM: 5.7M, TRACKSHOES: 500MM, NO BUCKET											210X LC MONO
Reach	3m		4.5m		6m		7.5m		Capacity at Max. Reach		
											
Load Point Height	kg	kg	kg	kg	kg	kg	kg	kg	kg	kg	mm
6m					5400*	5110			5400*	4160	6760
4.5m			6860*	6860*	5860*	4950			5310*	3460	7491
3m			8670*	7180	6650*	4720	5300	3370	4910	3120	7872
1.5m			10210*	6730	7270	4500	5190	3270	4750	3000	7954
0m			10870*	6520	7110	4350	5120	3210	4890	3070	7746
- 1.5m	10960*	10960*	10720*	6490	7060	4310			5400	3370	7223
- 3m	13500*	12880	9770*	6590	7150	4390			6630*	4120	6305
- 4.5m	10130*	10130*	7170*	6890					6590*	6350	4767

LIFT CAPACITIES – DIPPER LENGTH: 3.0M, MONOBOOM: 5.7M, TRACKSHOES: 500MM, NO BUCKET											210X LC MONO
Reach	3m		4.5m		6m		7.5m		Capacity at Max. Reach		
											
Load Point Height	kg	kg	kg	kg	kg	kg	kg	kg	kg	kg	mm
7.5m					4670*	4670*			3980*	3980*	6235
6m									3730*	3670	7339
4.5m					5300*	5020	5000*	3490	3690*	3110	8017
3m	12250*	12250*	7800*	7320	6140*	4760	5320	3380	3810*	2820	8374
1.5m			9550*	6780	7030*	4500	5170	3250	4080*	2710	8451
0m	6500*	6500*	10560*	6470	7060	4310	5070	3150	4410	2750	8255
- 1.5m	10820*	10820*	10750*	6360	6970	4220	5030	3120	4790	2980	7767
- 3m	14570*	12540	10170*	6420	7000	4250			5690	3520	6923
- 4.5m	11880*	11880*	8450*	6630					6500*	4920	5562

LIFT CAPACITIES – DIPPER LENGTH: 2.4M, MONOBOOM: 5.7M, TRACKSHOES: 500MM, NO BUCKET											220X LC MONO
Reach	3m		4.5m		6m		7.5m		Capacity at Max. Reach		
											
Load Point Height	kg	kg	kg	kg	kg	kg	kg	kg	kg	kg	mm
7.5m									5600*	5600*	5539
6m					5400*	5400*			5400*	4620	6760
4.5m			6860*	6860*	5860*	5490			5310*	3870	7491
3m			8670*	7970	6650*	5260	5780*	3780	5390	3510	7872
1.5m			10210*	7510	7440*	5030	5700	3680	5230	3380	7954
0m			10870*	7300	7800	4890	5630	3610	5380	3460	7746
- 1.5m	10960*	10960*	10720*	7270	7750	4850			5940	3800	7223
- 3m	13500*	13500*	9770*	7370	7160*	4930			6630*	4360	6305
- 4.5m	10130*	10130*	7170*	7170*					6590*	6590*	4767



Lift capacity front and rear.



Lift capacity full circle.

Notes:

1. Lifting capacities are based on ISO 10567, that is: 75% of minimum tipping load or 87% of hydraulic lift capacity, whichever is the less. Lifting capacities marked* are based on hydraulic capacity.
2. Lift capacities assume that the machine is on firm, level ground.
3. Lift capacities may be limited by local regulations. Please refer to your dealer.

SPECIFICATION 210X LC, 220X LC/SLC

LIFT CAPACITIES – DIPPER LENGTH: 3.0M, MONOBOOM: 5.7M, TRACKSHOES: 500MM, NO BUCKET											220X LC MONO
Reach	3m		4.5m		6m		7.5m		Capacity at Max. Reach		
											
Load Point Height	kg	kg	kg	kg	kg	kg	kg	kg	kg	kg	mm
7.5m					4670*	4670*			3980*	3980*	6235
6m									3730*	3730*	7339
4.5m					5300*	5300*	5000*	3900	3690*	3480	8017
3m	12250*	12250*	7800*	7800*	6140*	5290	5370*	3780	3810*	3180	8374
1.5m			9550*	7560	7030*	5030	5690	3660	4080*	3060	8451
0m	6500*	6500*	10560*	7250	7690*	4840	5580	3560	4570*	3110	8255
- 1.5m	10820*	10820*	10750*	7150	7660	4760	5540	3520	5280	3370	7767
- 3m	14570*	14000	10170*	7200	7530*	4780			6240*	3970	6923
- 4.5m	11880*	11880*	8450*	7410					6500*	5510	5562

LIFT CAPACITIES – DIPPER LENGTH: 2.4M, T.A.B.: 5.7M, TRACKSHOES: 500MM, NO BUCKET											220X LC T.A.B.
Reach	3m		4.5m		6m		7.5m		Capacity at Max. Reach		
											
Load Point Height	kg	kg	kg	kg	kg	kg	kg	kg	kg	kg	mm
9m									7300*	7300*	3459
7.5m			7060*	7060*					5610*	5610*	5628
6m			7300*	7300*	6450*	5690			5110*	4560	6833
4.5m			8350*	8350*	6810*	5520	5460*	3870	4960*	3820	7557
3m			9760*	7960	7390*	5260	5850	3780	5040*	3460	7935
1.5m			10690*	7440	7860*	5010	5730	3670	5190	3330	8016
0m			10660*	7210	7810	4850	5650	3600	5340	3410	7809
- 1.5m	10420*	10420*	9770*	7180	7400*	4800			5580*	3740	7291
- 3m			7950*	7300	5810*				5080*	4540	6383

LIFT CAPACITIES – DIPPER LENGTH: 3.0M, T.A.B.: 5.7M, TRACKSHOES: 500MM, NO BUCKET											220X LC T.A.B.
Reach	3m		4.5m		6m		7.5m		Capacity at Max. Reach		
											
Load Point Height	kg	kg	kg	kg	kg	kg	kg	kg	kg	kg	mm
9m			4470*	4470*					4240*	4240*	4568
7.5m					4690*	4690*			3520*	3520*	6364
6m			6070*	6070*	5940*	5820			3260*	3260*	7449
4.5m	8760*	8760*	7640*	7640*	6380*	5620	5480*	3940	3190*	3190*	8118
3m			9130*	8170	7040*	5340	5900	3820	3250*	3140	8470
1.5m			10360*	7570	7640*	5060	5740	3680	3440*	3030	8546
0m	6040*	6040*	10730*	7230	7810	4850	5630	3570	3790*	3080	8353
- 1.5m	10320*	10320*	10210*	7120	7640*	4760	5580	3530	4410*	3320	7871
- 3m	11650*	11650*	8810*	7180	6590*	4790			5040*	3900	7040



Lift capacity front and rear.



Lift capacity full circle.

Notes:

1. Lifting capacities are based on ISO 10567, that is: 75% of minimum tipping load or 87% of hydraulic lift capacity, whichever is the less. Lifting capacities marked* are based on hydraulic capacity.
2. Lift capacities assume that the machine is on firm, level ground.
3. Lift capacities may be limited by local regulations. Please refer to your dealer.

SPECIFICATION 210X LC, 220X LC/SLC

LIFT CAPACITIES – DIPPER LENGTH: 2.4M, MONOBOOM: 5.7M, TRACKSHOES: 500MM, NO BUCKET											220X SLC MONO
Reach	3m		4.5m		6m		7.5m		Capacity at Max. Reach		
											
Load Point Height	kg	kg	kg	kg	kg	kg	kg	kg	kg	kg	mm
7.5m									5600*	5600*	5539
6m					5400*	5120			5400*	4190	6760
4.5m			6860*	6860*	5860*	4970			5310*	3500	7491
3m			8670*	7130	6650*	4740	5770	3410	5350	3160	7872
1.5m			10210*	6690	7440*	4520	5660	3320	5190	3050	7954
0m			10870*	6490	7740	4380	5590	3250	5340	3110	7746
- 1.5m	10960*	10960*	10720*	6460	7690	4340			5890	3410	7223
- 3m	13500*	12440	9770*	6560	7160*	4420			6630*	4160	6305
- 4.5m	10130*	10130*	7170*	6850					6590*	6330	4767

LIFT CAPACITIES – DIPPER LENGTH: 3.0M, MONOBOOM: 5.7M, TRACKSHOES: 500MM, NO BUCKET											220X SLC MONO
Reach	3m		4.5m		6m		7.5m		Capacity at Max. Reach		
											
Load Point Height	kg	kg	kg	kg	kg	kg	kg	kg	kg	kg	mm
7.5m					4670*	4670*			3980*	3980*	6235
6m									3730*	3710	7339
4.5m					5300*	5030	5000*	3530	3690*	3150	8017
3m	12250*	12250*	7800*	7260	6140*	4770	5370*	3420	3810*	2860	8374
1.5m			9550*	6740	7030*	4520	5640	3290	4080*	2750	8451
0m	6500*	6500*	10560*	6430	7690*	4340	5540	3190	4570*	2800	8255
- 1.5m	10820*	10820*	10750*	6340	7610	4250	5500	3160	5240	3020	7767
- 3m	14570*	12120	10170*	6390	7530*	4280			6210	3560	6923
- 4.5m	11880*	11880*	8450*	6590					6500*	4930	5562

LIFT CAPACITIES – DIPPER LENGTH: 2.4M, MONOBOOM: 5.7M, TRACKSHOES: 600MM, NO BUCKET											220X LC DOZER MONO
Reach	3m		4.5m		6m		7.5m		Capacity at Max. Reach		
											
Load Point Height	kg	kg	kg	kg	kg	kg	kg	kg	kg	kg	mm
7.5m									5600*	5600*	5539
6m					5400*	5400*			5400*	4940	6760
4.5m			6860*	6860*	5860*	5860			5310*	4150	7491
3m			8670*	8510	6650*	5630	5780*	4060	5450*	3770	7872
1.5m			10210*	8060	7440*	5410	6120*	3960	5840*	3640	7954
0m			10870*	7850	7940*	5260	6330*	3900	6080	3730	7746
- 1.5m	10960*	10960*	10720*	7820	7960*	5220			6390*	4090	7223
- 3m	13500*	13500*	9770*	7920	7160*	5300			6630*	4980	6305
- 4.5m	10130*	10130*	7170*	7170*					6590*	6590*	4767



Lift capacity front and rear.



Lift capacity full circle.

Notes:

1. Lifting capacities are based on ISO 10567, that is: 75% of minimum tipping load or 87% of hydraulic lift capacity, whichever is the less. Lifting capacities marked* are based on hydraulic capacity.
2. Lift capacities assume that the machine is on firm, level ground.
3. Lift capacities may be limited by local regulations. Please refer to your dealer.

SPECIFICATION 210X LC, 220X LC/SLC

LIFT CAPACITIES – DIPPER LENGTH: 3.0M, MONOBOOM: 5.7M, TRACKSHOES: 600MM, NO BUCKET											220X LC DOZER MONO
Reach	3m		4.5m		6m		7.5m		Capacity at Max. Reach		
											
Load Point Height	kg	kg	kg	kg	kg	kg	kg	kg	kg	kg	mm
7.5m					4670*	4670*			3980*	3980*	6235
6m									3730*	3730*	7339
4.5m					5300*	5300*	5000*	4180	3690*	3690*	8017
3m	12250*	12250*	7800*	7800*	6140*	5660	5370*	4070	3810*	3430	8374
1.5m			9550*	8110	7030*	5400	5820*	3940	4080*	3310	8451
0m	6500*	6500*	10560*	7790	7690*	5220	6160*	3840	4570*	3370	8255
- 1.5m	10820*	10820*	10750*	7690	7920*	5130	6190*	3800	5450*	3640	7767
- 3m	14570*	14570*	10170*	7740	7530*	5160			6240*	4280	6923
- 4.5m	11880*	11880*	8450*	7950					6500*	5920	5562

LIFT CAPACITIES – DIPPER LENGTH: 2.4M, T.A.B.: 5.7M, TRACKSHOES: 600MM, NO BUCKET											220X LC DOZER T.A.B.
Reach	3m		4.5m		6m		7.5m		Capacity at Max. Reach		
											
Load Point Height	kg	kg	kg	kg	kg	kg	kg	kg	kg	kg	mm
9m									7300*	7300*	3459
7.5m			7060*	7060*					5610*	5610*	5628
6m			7300*	7300*	6450*	6070			5110*	4880	6833
4.5m			8350*	8350*	6810*	5900	5460*	4150	4960*	4100	7557
3m			9760*	8500	7390*	5630	6170*	4060	5040*	3720	7935
1.5m			10690*	7990	7860*	5380	6290*	3950	5330*	3590	8016
0m			10660*	7760	7930*	5220	6140*	3880	5770*	3680	7809
- 1.5m	10420*	10420*	9770*	7730	7400*	5180			5580*	4030	7291
- 3m			7950*	7850	5810*	5270			5080*	4880	6383

LIFT CAPACITIES – DIPPER LENGTH: 3.0M, T.A.B.: 5.7M, TRACKSHOES: 600MM, NO BUCKET											220X LC DOZER T.A.B.
Reach	3m		4.5m		6m		7.5m		Capacity at Max. Reach		
											
Load Point Height	kg	kg	kg	kg	kg	kg	kg	kg	kg	kg	mm
9m			4470*	4470*					4240*	4240*	4568
7.5m					4690*	4690*			3520*	3520*	6364
6m			6070*	6070*	5940*	5940*			3260*	3260*	7449
4.5m	8760*	8760*	7640*	7640*	6380*	6000	5480*	4220	3190*	3190*	8118
3m			9130*	8710	7040*	5710	5920*	4100	3250*	3250*	8470
1.5m			10360*	8110	7640*	5430	6170*	3960	3440*	3270	8546
0m	6040*	6040*	10730*	7780	7900*	5220	6210*	3850	3790*	3330	8353
- 1.5m	10320*	10320*	10210*	7670	7640*	5130	5800*	3810	4410*	3590	7871
- 3m	11650*	11650*	8810*	7730	6590*	5160			5040*	4210	7040



Lift capacity front and rear.





















Lift capacity full circle.

Notes:

1. Lifting capacities are based on ISO 10567, that is: 75% of minimum tipping load or 87% of hydraulic lift capacity, whichever is the less. Lifting capacities marked* are based on hydraulic capacity.
2. Lift capacities assume that the machine is on firm, level ground.
3. Lift capacities may be limited by local regulations. Please refer to your dealer.

SPECIFICATION 210X LC, 220X LC/SLC

LIFT CAPACITIES – DIPPER LENGTH: 6.4M, MONOBOOM: 8.7M, TRACKSHOES: 500MM, NO BUCKET																		220X LC LR MONO				
Reach	3m		4.5m		6m		7.5m		9m		10.5m		12m		13.5m		Capacity at Max. Reach					
																			kg	kg	mm	
Load Point Height	kg	kg	kg	kg	kg	kg	kg	kg	kg	kg	kg	kg	kg	kg	kg	kg	kg	kg	kg	kg	mm	
11.5m																			1370*	1370*	10801	
10.5m																			1310*	1310*	11627	
9m														2020*	1890				1250*	1250*	12615	
7.5m														2090*	1870				1230*	1230*	13363	
6m														2220*	2220*	2170*	1820	1860*	1380	1220*	1220*	13909
4.5m									2580*	2580*	2410*	2250	2290*	1730	2220*	1340			1240*	1160	14276	
3m	8960*	8960*			4090*	4090*	3370*	3370*	2930*	2720	2640*	2090	2450*	1630	2180	1280			1270*	1080	14478	
1.5m	3210*	3210*	7070*	6520	4970*	4450	3910*	3260	3280*	2490	2880*	1940	2580	1530	2110	1210			1320*	1030	14523	
0m	3290*	3290*	7600*	5730	5710*	3960	4400*	2940	3620*	2280	3040	1800	2480	1440	2050	1150			1410*	1010	14410	
- 1.5m	4200*	4200*	7280*	5350	6210*	3640	4700	2710	3640	2110	2920	1680	2390	1360	2000	1110			1520*	1020	14138	
- 3m	5350*	5350*	8020*	5210	6280	3470	4540	2570	3520	2000	2830	1600	2340	1310	1980	1090			1680*	1070	13695	
- 4.5m	6660*	6660*	8860*	5220	6220	3420	4470	2500	3460	1940	2790	1560	2320	1290					1910*	1150	13066	
- 6m	8180*	8180*	8520*	5320	6250	3450	4480	2510	3460	1940	2800	1570	2350	1320					2260*	1290	12220	
- 7.5m	9960*	9960*	7900*	5510	6040*	3550	4550	2580	3520	2000	2870	1640							2680	1540	11107	
- 9m	9560*	9560*	6900*	5800	5350*	3750	4260*	2720	3390*	2140									3020*	1980	9636	
- 10.5m			5280*	5280*	4110*	4060	3110*	3010											3040*	2960	7598	



Lift capacity front and rear.



Lift capacity full circle.

Notes:

1. Lifting capacities are based on ISO 10567, that is: 75% of minimum tipping load or 87% of hydraulic lift capacity, whichever is the less. Lifting capacities marked* are based on hydraulic capacity.
2. Lift capacities assume that the machine is on firm, level ground.
3. Lift capacities may be limited by local regulations. Please refer to your dealer.



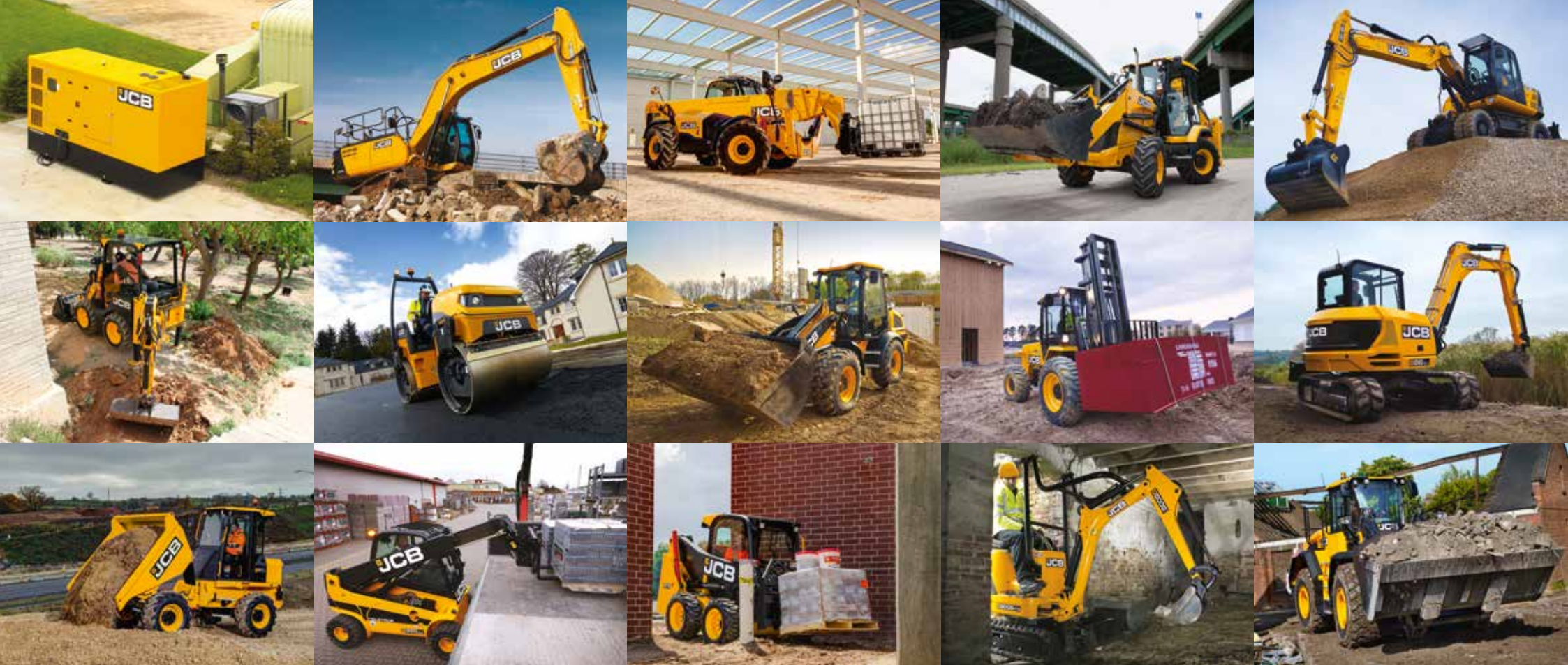

ONE COMPANY, OVER 300 MACHINES.

Your nearest JCB dealer

Tracked Excavator 220X
 Max Engine Power: 129KW Max Operating weight: 24,743kg Max Bucket capacity: 1.25 m²

JCB Sales Limited, Rokester, Staffordshire, United Kingdom ST14 5JP.
 Tel: +44 (0)1889 590312 Email: salesinfo@jcb.com
 Download the very latest information on this product range at: www.jcb.com

©2021 JCB Sales. All rights reserved. No part of this publication may be reproduced, stored in a retrieval system, or transmitted in any form or by any other means, electronic, mechanical, photocopying or otherwise, without prior permission from JCB Sales. All references in this publication to operating weights, sizes, capacities and other performance measurements are provided for guidance only and may vary dependant upon the exact specification of machine. They should not therefore be relied upon in relation to suitability for a particular application. Guidance and advice should always be sought from your JCB Dealer. JCB reserves the right to change specifications without notice. Illustrations and specifications shown may include optional equipment and accessories. All images are correct at time of print. The JCB logo is a registered trademark of J.C. Bamford Excavators Ltd.

